



Alumil
Building excellence every day

Alumil  **SMARTIA**
Barcode Cladding



CONTENTS

SMARTIA BARCODE CLADDING

INTRODUCTION	4
DECORATIVE SOLUTIONS	
/ ALUMINIUM PROFILES	8
/ WOODALUX®	10
/ LIGHTING	12
/ PERFORATION	14
ALUMINIUM SUBFRAME	20
APPLICATIONS & TYPOLOGIES	22



SMARTIA BARCODE CLADDING

is the ideal series for wall-cladding applications and undoubtedly an astonishingly useful tool for architects, contributing to the design of impressive constructions, and fully or partially covering buildings in a unique style.

Create Cladding

Façades in Style

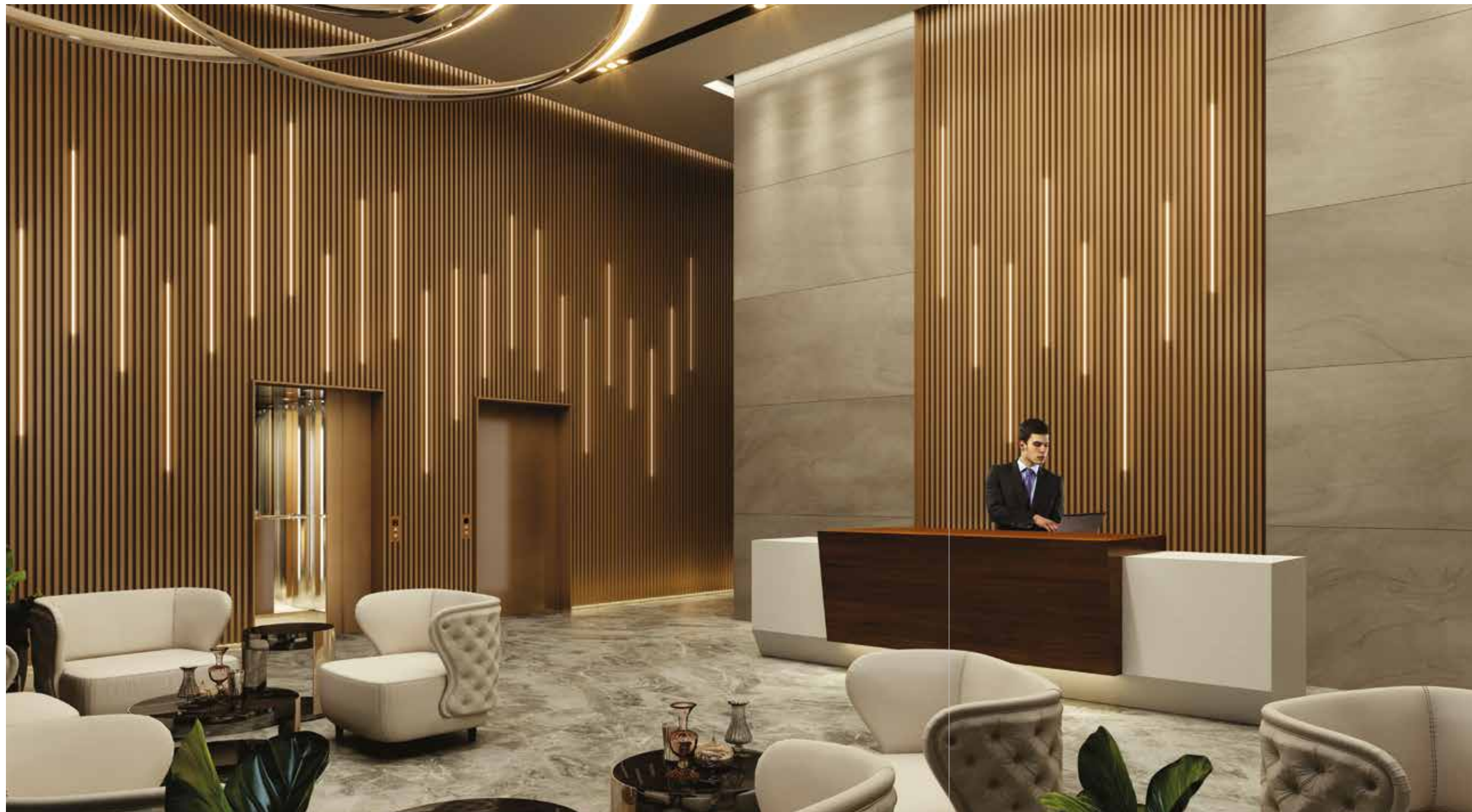

- Aimed at covering many types of buildings, i.e., of commercial & office use, as well as modern residences with unlimited possibilities.
- Applied both at the exterior and the interior, on the wall and the ceiling, upgrading overall aesthetics and energy levels.
- Mainly based on a wide selection of aluminium profiles and integrated with other elements, e.g., wood composite Woodalux®, LED lighting, perforated surfaces, etc.
- Allows innovative combinations of cladding surfaces with fences, gates, garage doors etc., following the same design.



Top aesthetics - **modern minimalistic** constructions, which create new architectural trends.

INCOMPARABLE

- **Innovation** – high levels of differentiation and very interesting architectural proposals.
- **Robust construction** – very large surfaces can be covered, thanks to the integrated support system, made also of aluminium.
- **Resistance** – extreme corrosion resistance, thanks to the durability of aluminium and its surface treatment.

ADVANTAGES

- **Insulation** – it allows and at the same time protects the thermal insulation regardless of its thicknesses.
- **Technical applications** – it provides efficient solutions, even in cases characterized by technical complexity (cladding with curtain walls, windows, etc).
- **Decoration** - unlimited color choices, combined with LED lighting options and synthetic wood (Woodalux®).



Insightful projects require a smart variety of **decorative solutions**

A wide – constantly increasing - range of aluminium profiles is available, in order to **meet all the aesthetic needs of any project**. Either symmetric or asymmetric, with hollows or flat blades, the various profiles are firmly fixed with one another, offering a stylish result. Furthermore, they can **be combined with LED lighting strips, Woodalux® planks** and also with each other, for even more creative designs.



DECORATIVE SOLUTIONS

ALUMINIUM PROFILES

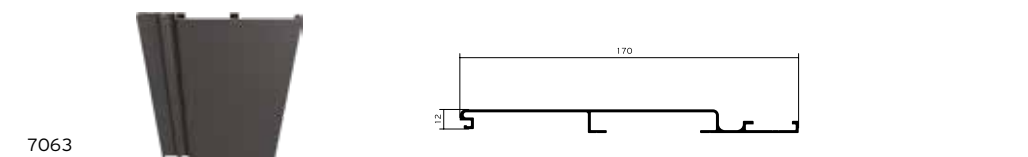
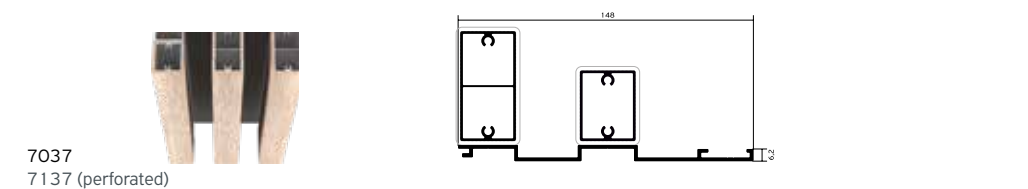
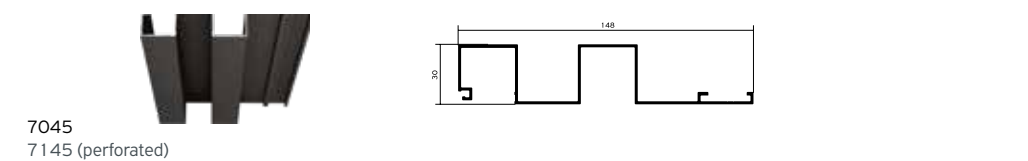
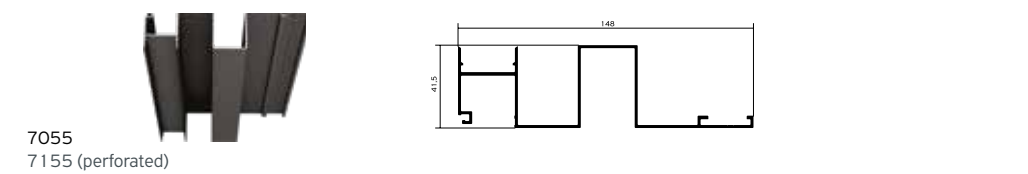
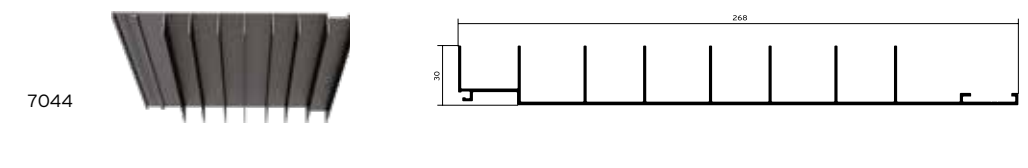
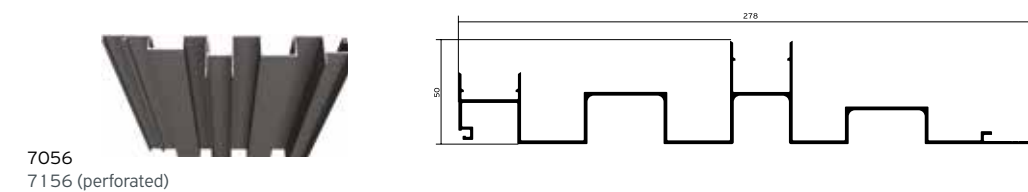
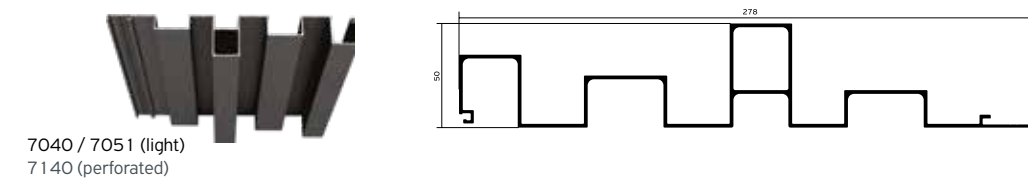
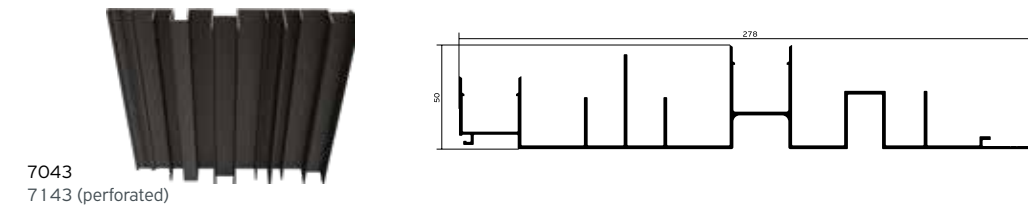

Innovative architectural solutions need **innovative building materials**



DECORATIVE SOLUTIONS

WOODALUX®



Aluminium profile, capped with wood-composite material, a multi-use building material, **suitable for long lasting decorative** constructions that naturally upgrade the buildings.

- It surpasses wood when placed outdoors and it is superior in terms of resistance against weather conditions, direct sunlight and wood-decaying factors. It needs no maintenance.
- Fixed on a special flat profile or combined with the rest cladding profiles, Woodalux® offers stylish creations.
- Available in various dimensions (32x40, 32x60, 32x80, 32x120 mm), nine colors and caps of the same material or aluminium.

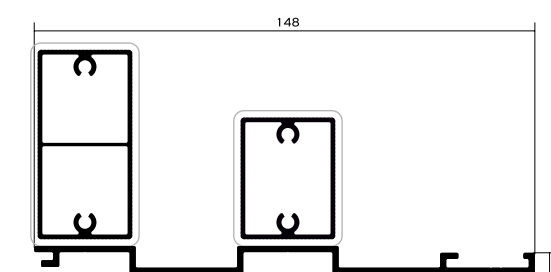

DECORATIVE SOLUTIONS

LIGHTING

Experience the numerous lighting options and bring **enlightened solutions into life!**

LED lighting strips are perfectly integrated in the aluminium profiles, as well as the overall architectural design, allowing endless creative customization.

Placed partially or all along the aluminium bars, the lighting options literally transform the cladding surface and the building itself, especially when sun goes down.

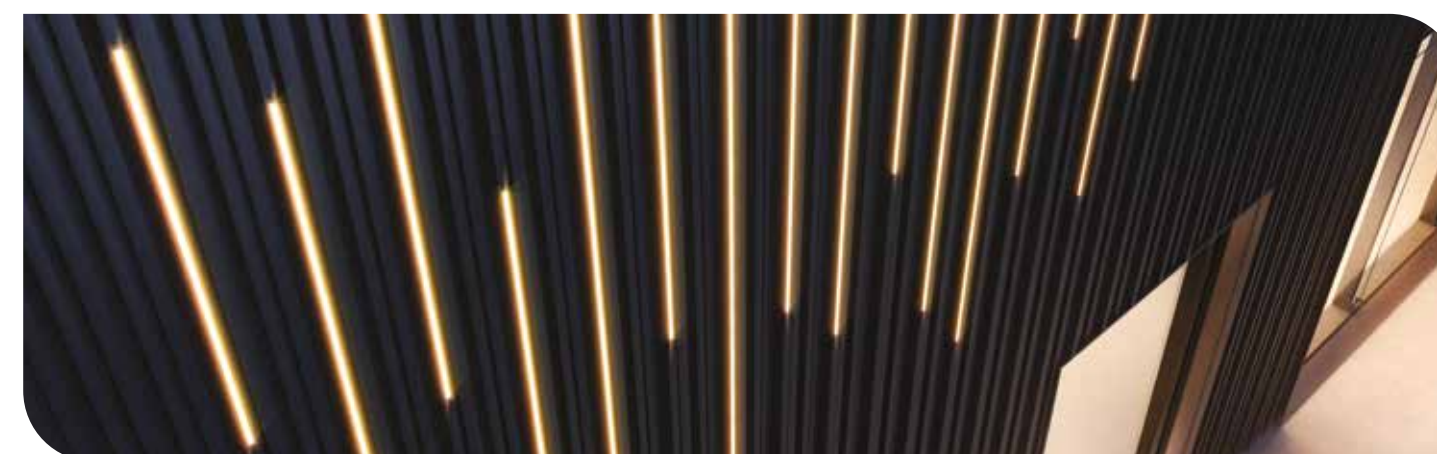
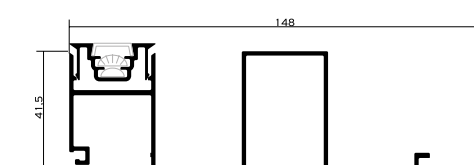
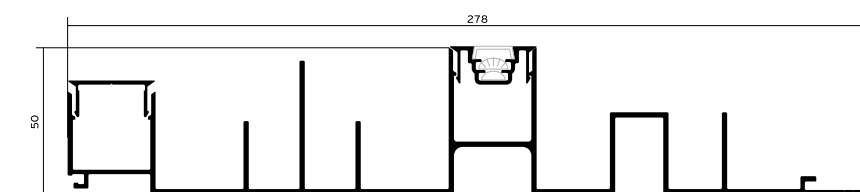
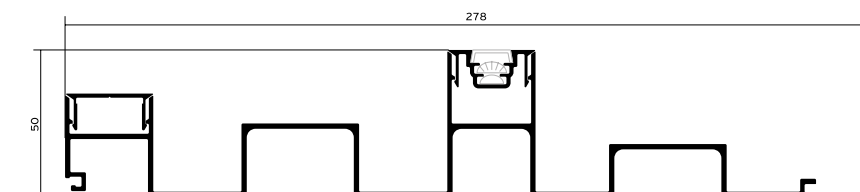

Shedding light
via **perforation**

Perforated profiles **allow the natural lighting during the day** and enhance the extra decorative play with **the artificial lighting during the night**.

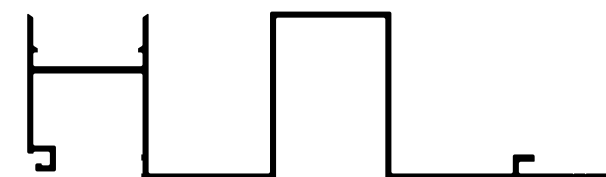
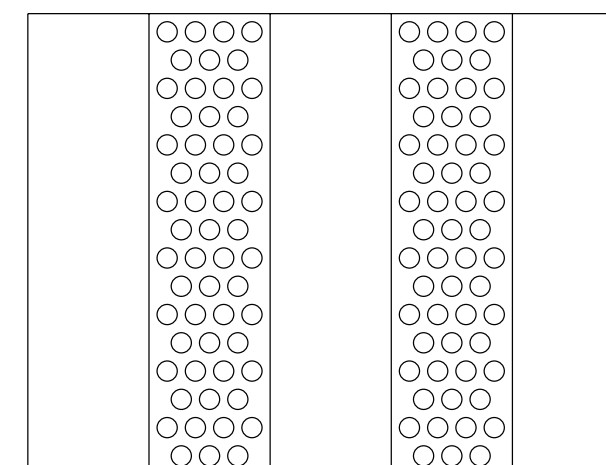
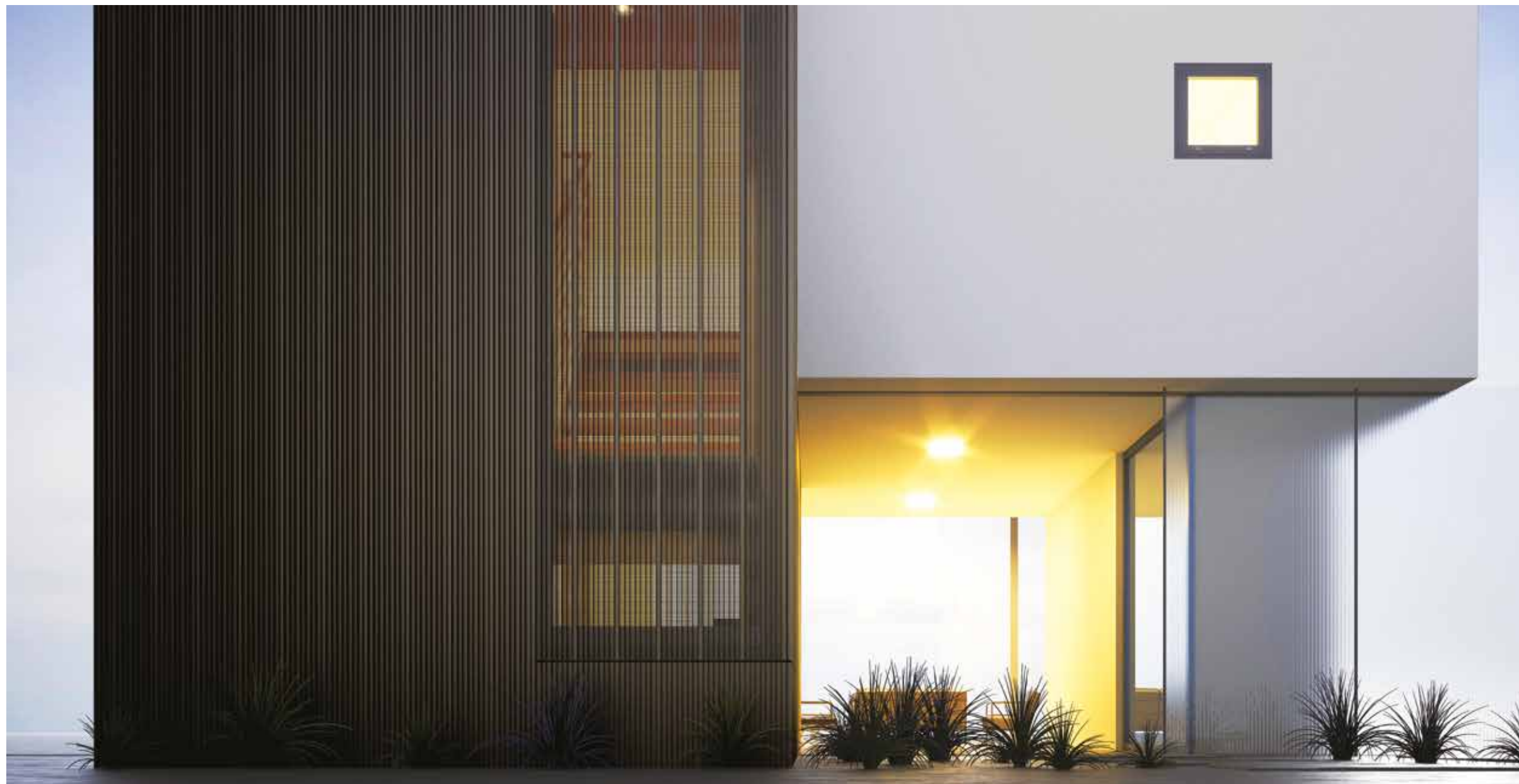

The dense round perforation (5 mm) along the inner channel of the profiles upgrades aesthetics & lighting.



Barcode cladding **applications indoors** on both walls and ceilings. Accompanied by lighting elements and sound reductive on materials, they offer **unique aesthetic** and **sound reduction properties**.

Ceiling application



Wall application



DECORATIVE SOLUTIONS

PERFORATION Square (30mm)

Unique decorative solutions
for **stylish shading & visibility**



The special square perforation 30mm can create stylish shading & transparency.



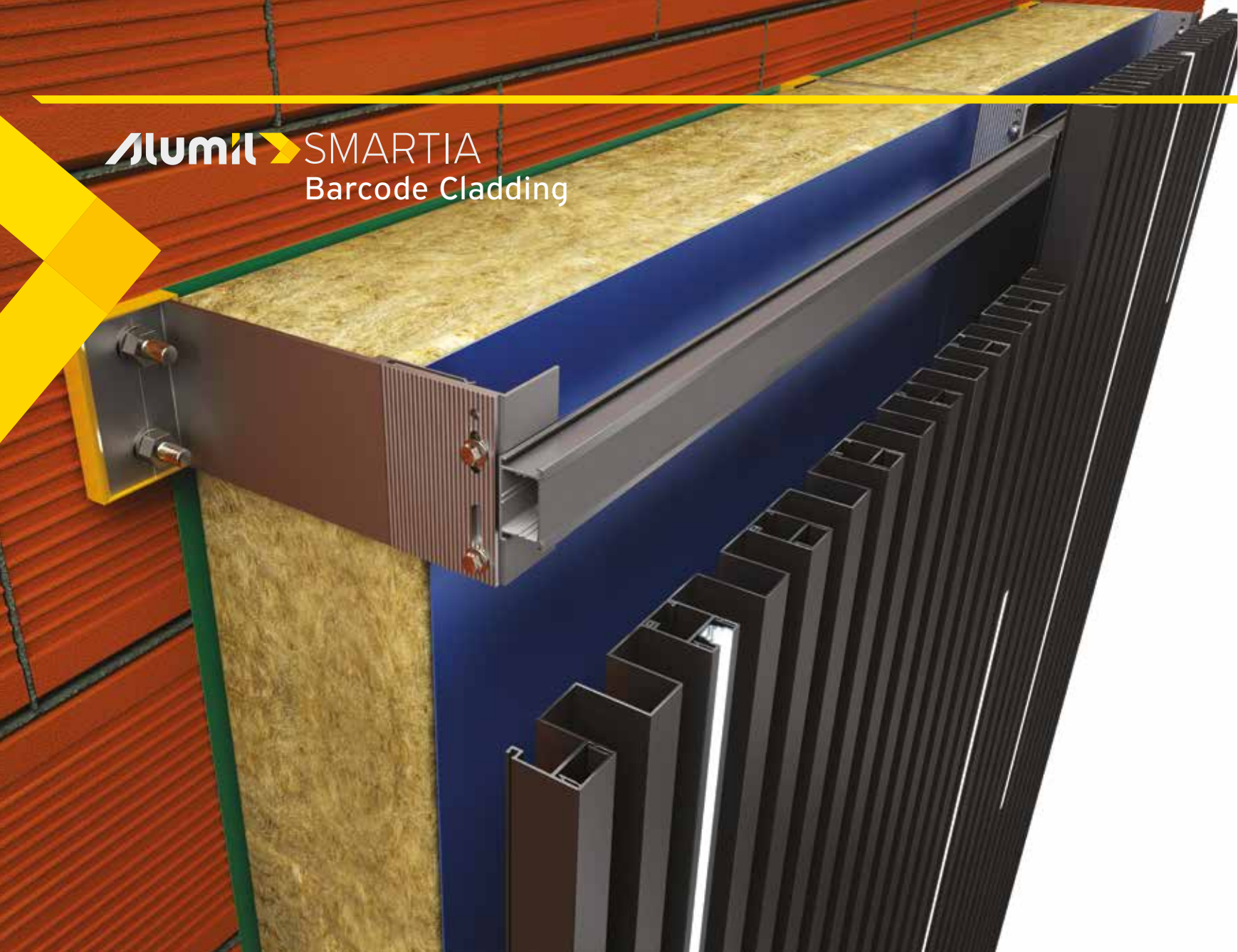

Solution for thermal insulation

The cladding system is accompanied with a robust and efficient aluminium subframe, which allows covering of very large surfaces, without limitation on insulation thickness. Furthermore, **the easy, fast and sturdy installation of the system provides high flexibility during its construction.**

- Great variety of aluminium brackets, to allow insulation thickness up to 200 mm.
- Special clip on the brackets for fast installation.
- Oval pre-made holes for flexible adjustments.
- Durable plastic pad, to avoid thermal bridging.
- Additional transom profiles, to create complex frames and overcome application complexities.
- Compatible with many other wall cladding materials, such as aluminium composite panels and sheets or wood composite planks (Woodee).

ALUMINIUM

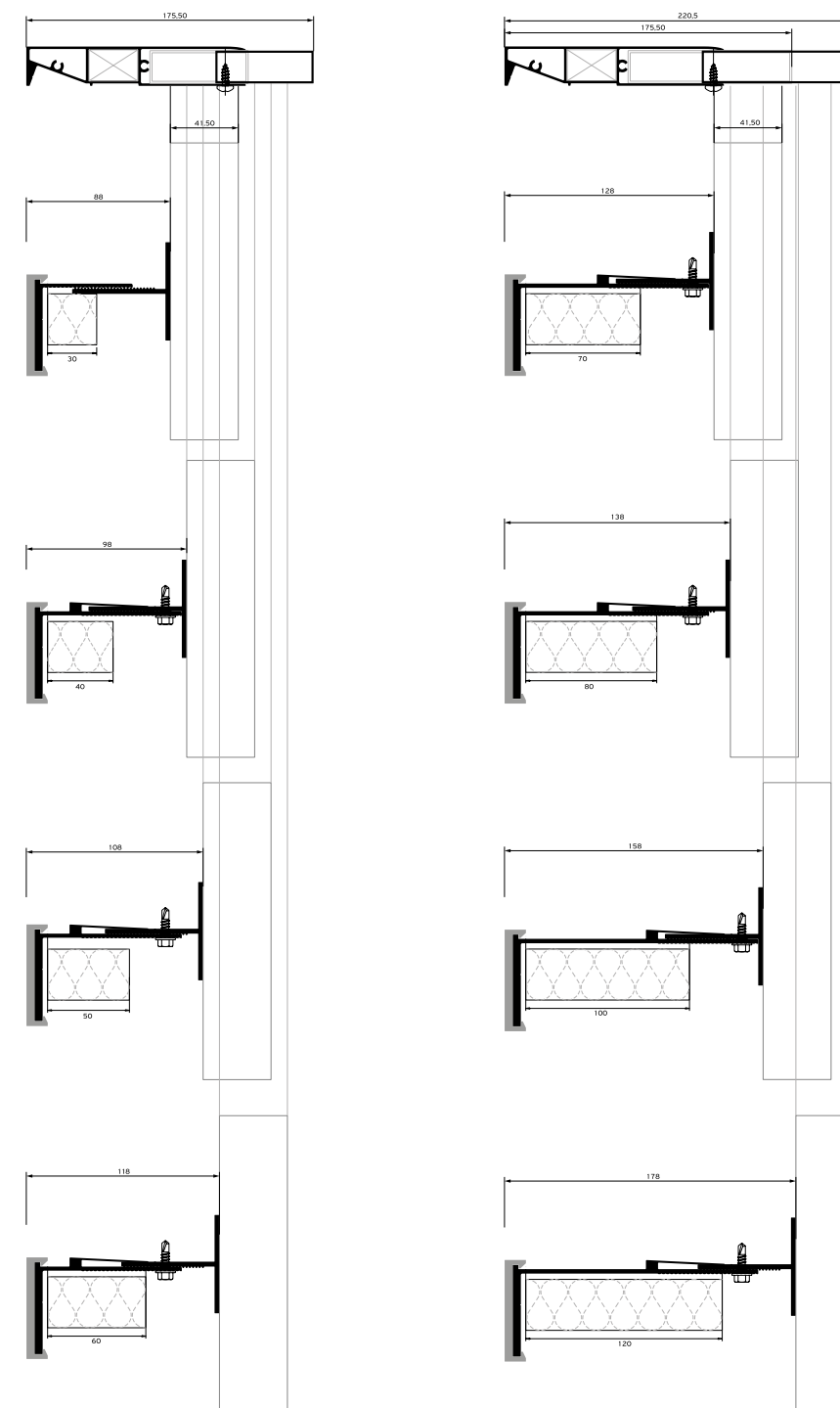

Minimum space 25mm between insulation & cladding material .
Final selection of insulation thickness & bracket size depends on project conditions.

SUBFRAME

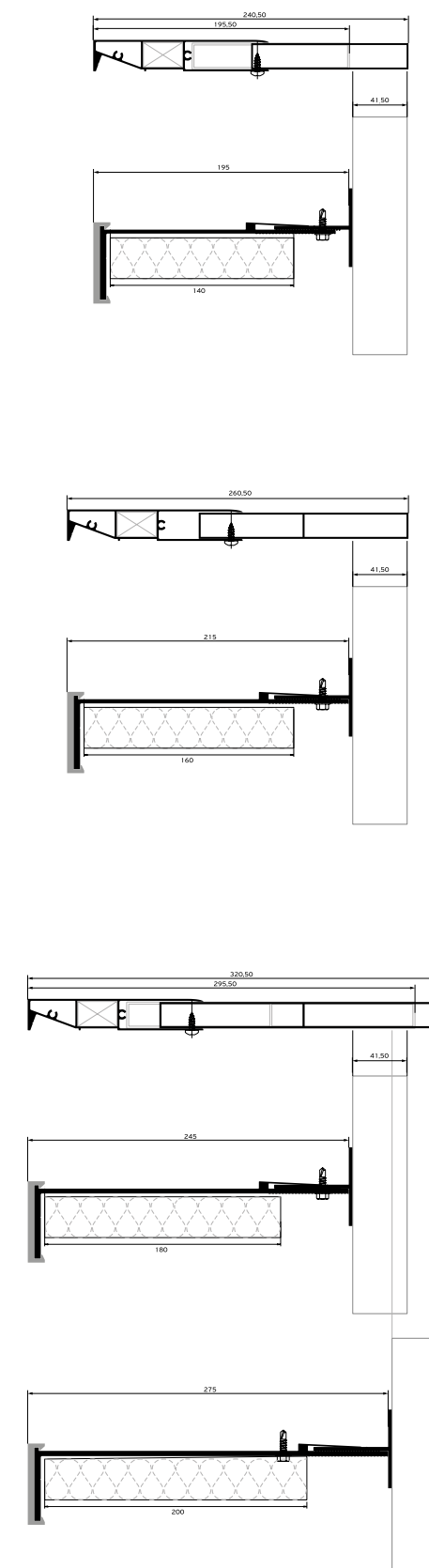

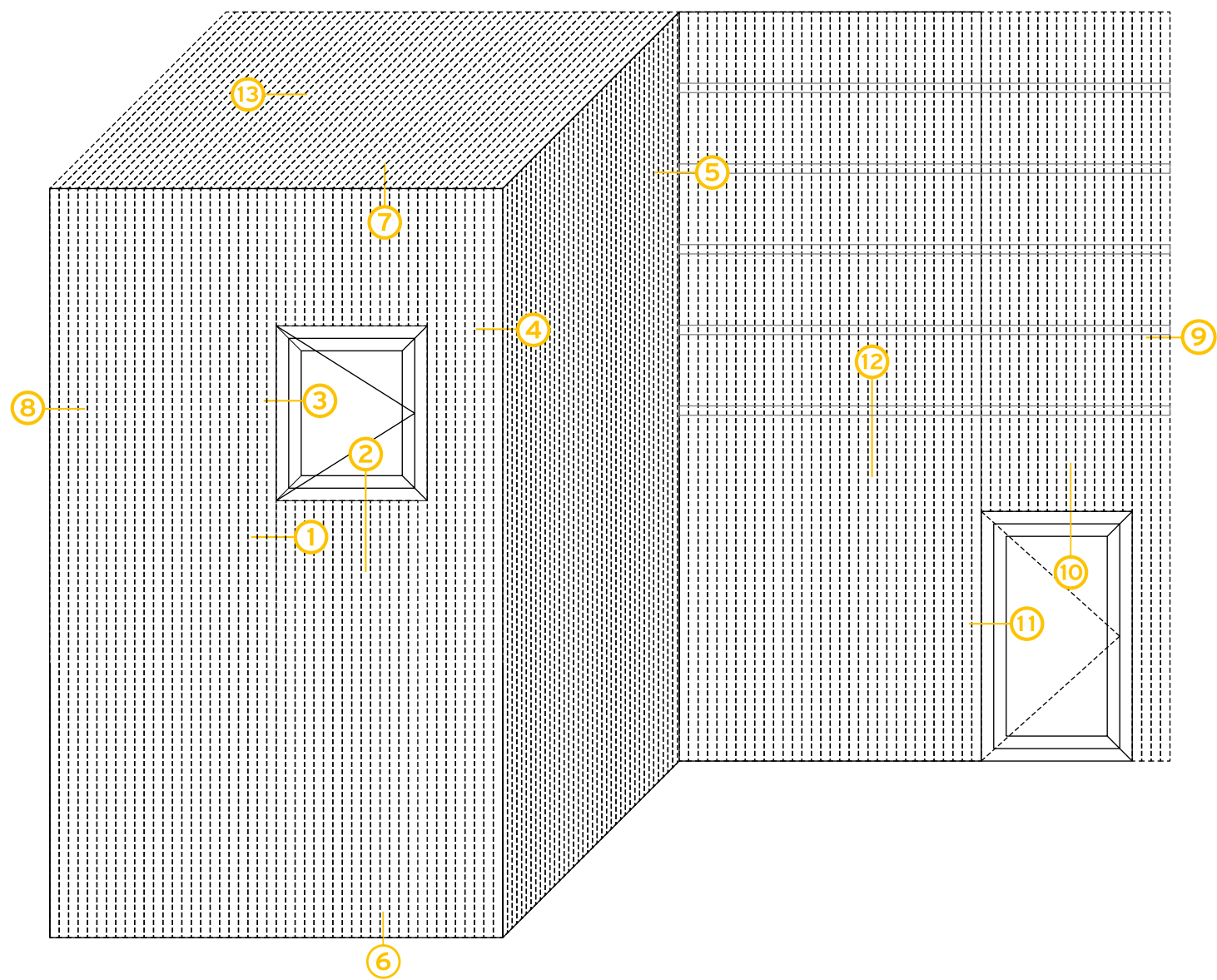

APPLICATIONS

& TYPOLOGIES

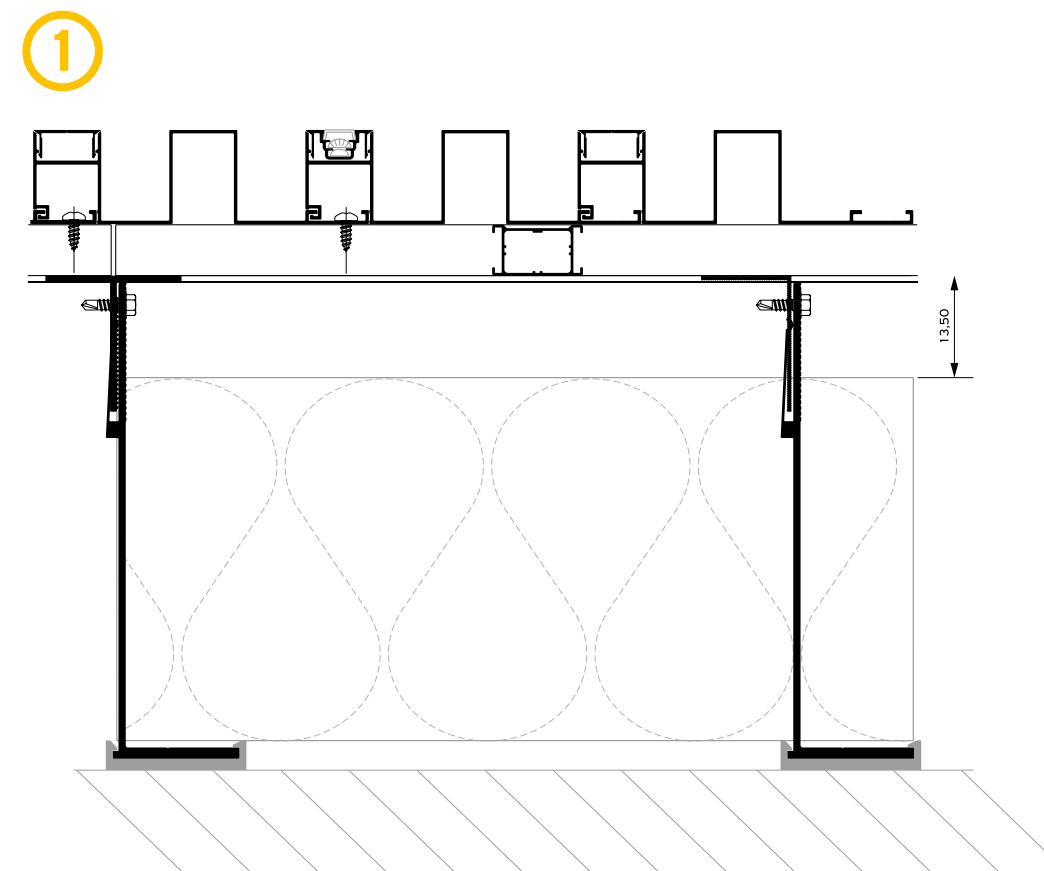

** In lighter constructions, the transom profile can be omitted*

Alumil SMARTIA
Barcode Cladding

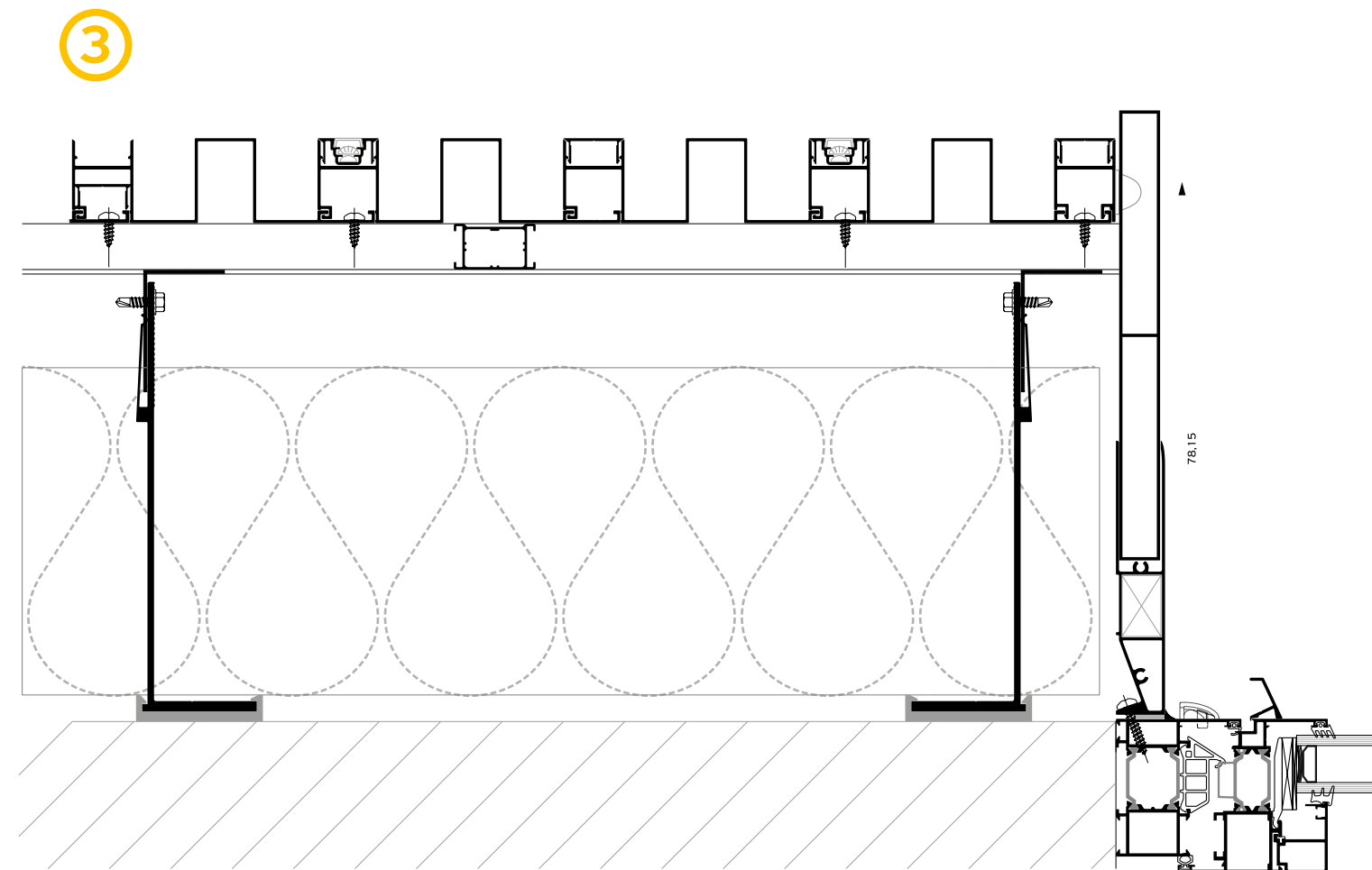
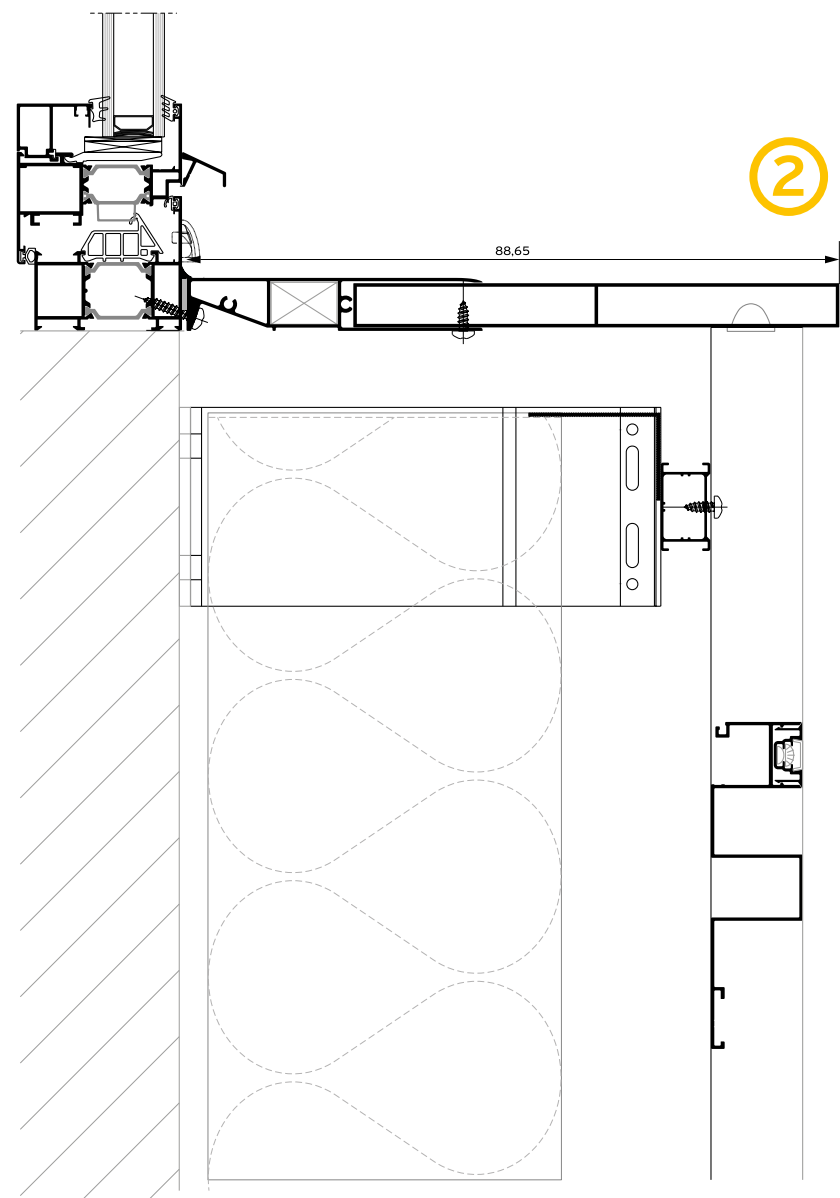
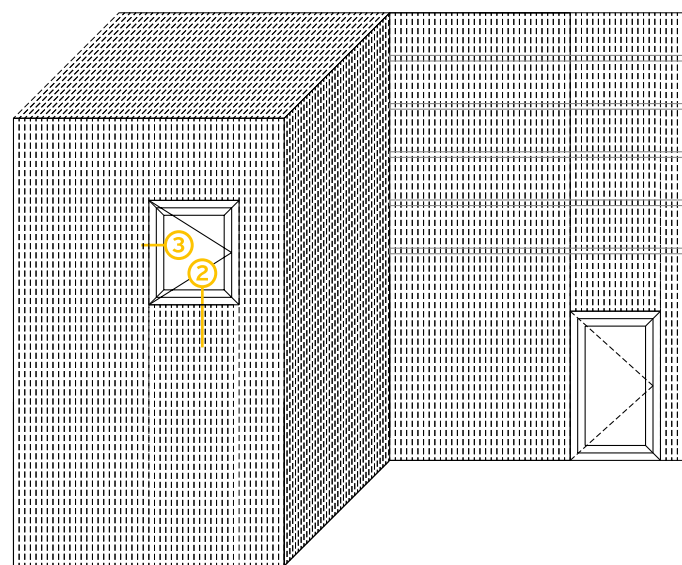

Alumil SMARTIA
Barcode Cladding

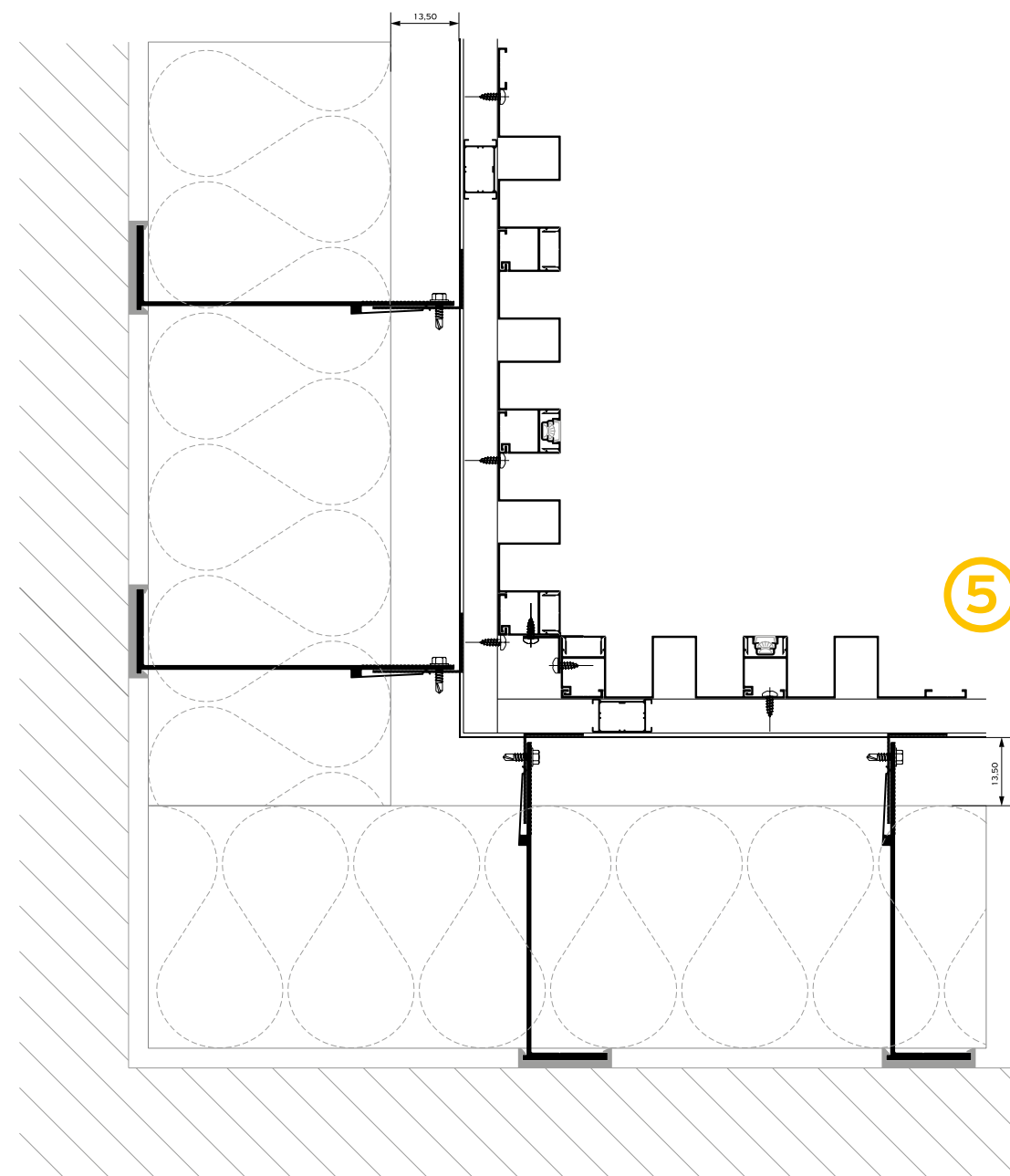
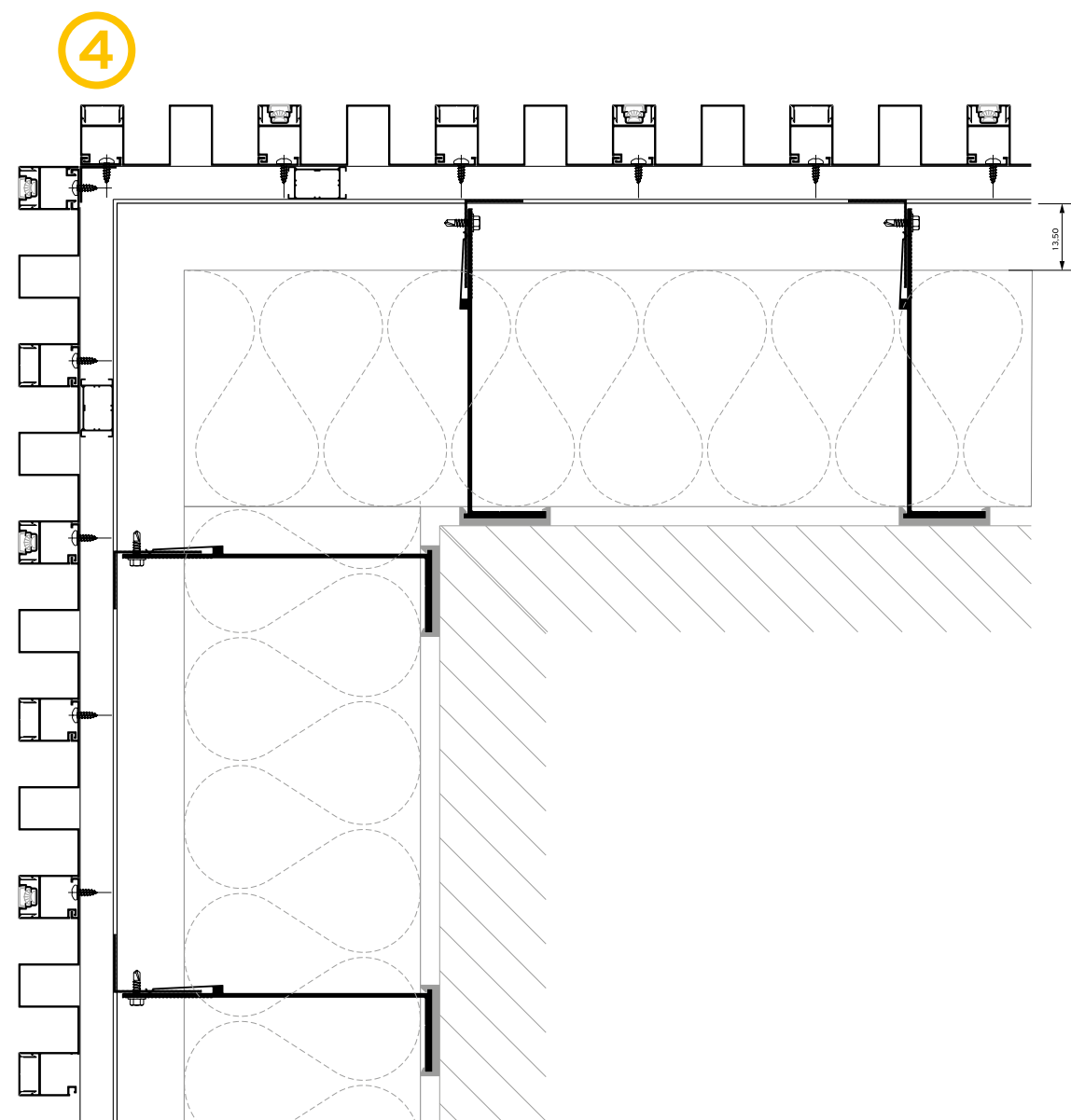
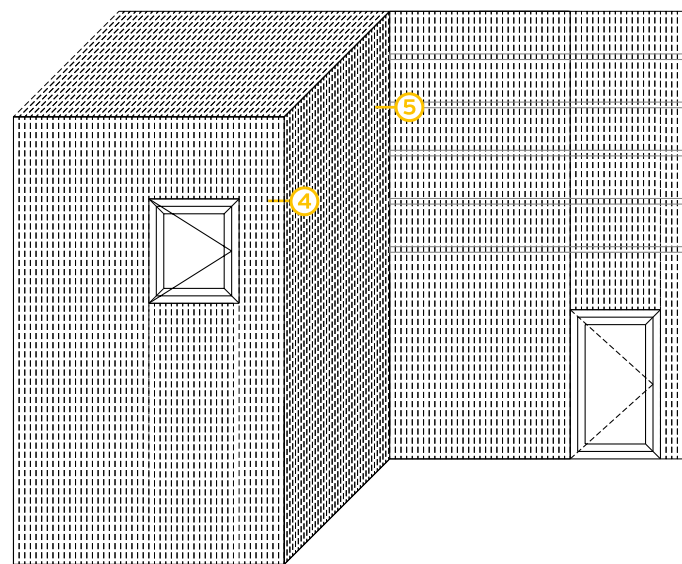

Alumil SMARTIA
Barcode Cladding

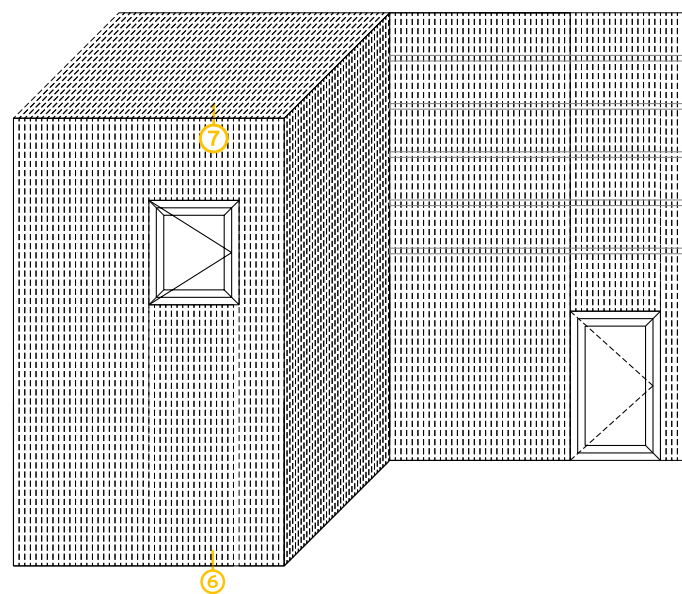

6

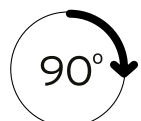
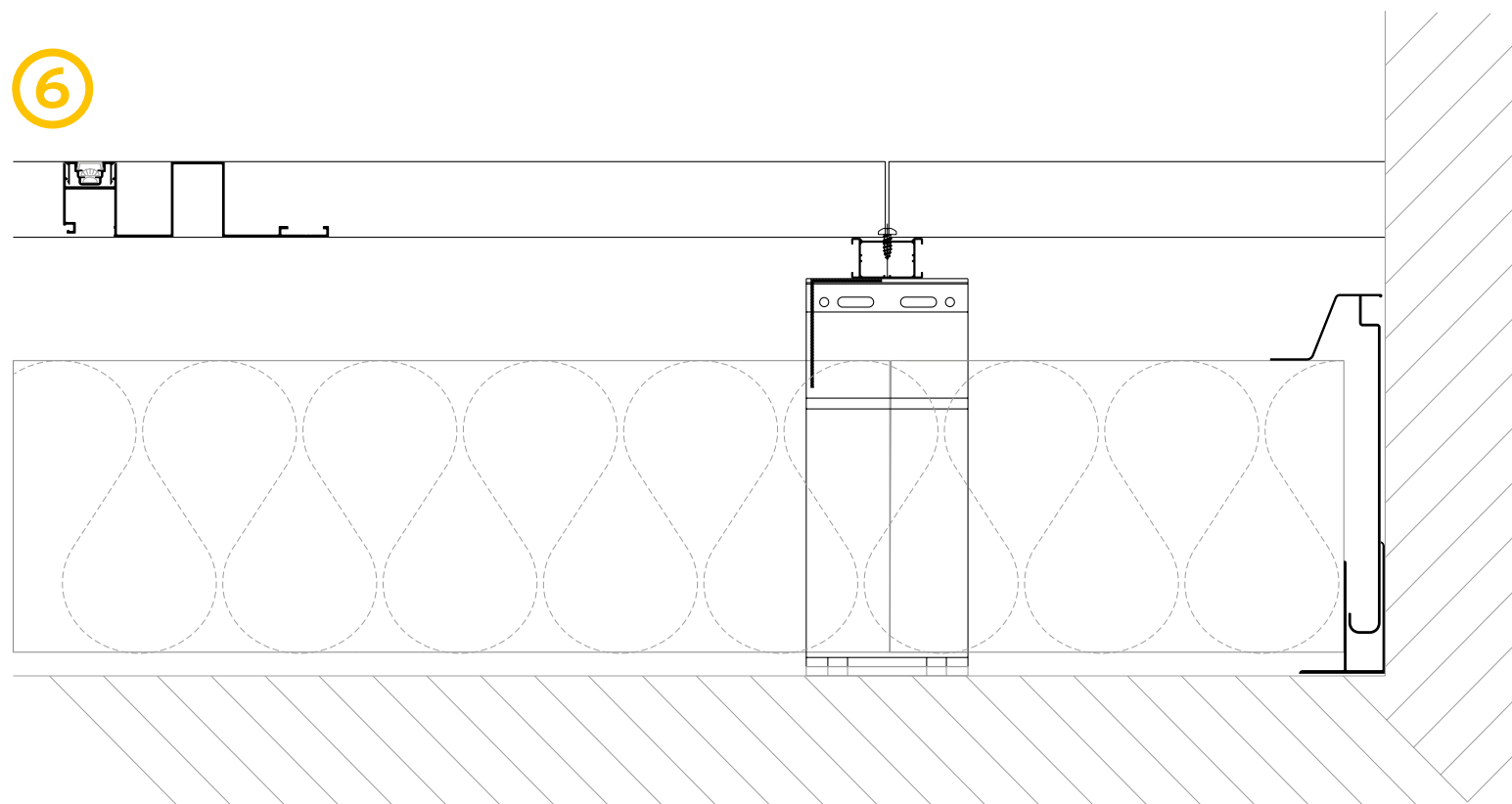

Rotate the technical drawing
90° CLOCKWISE IN ORDER
TO READ IT PROPERLY

7

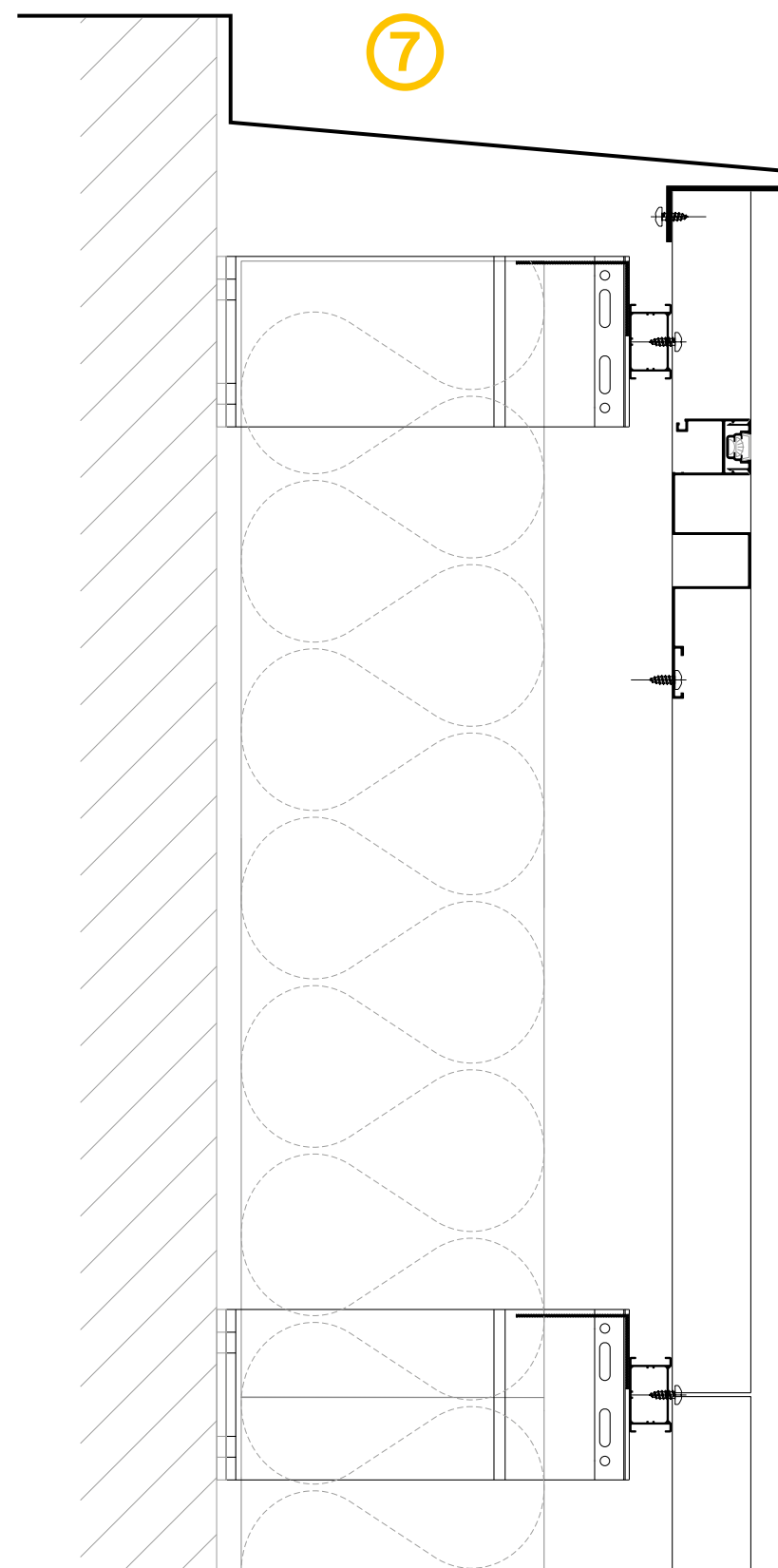

Alumil SMARTIA
Barcode Cladding

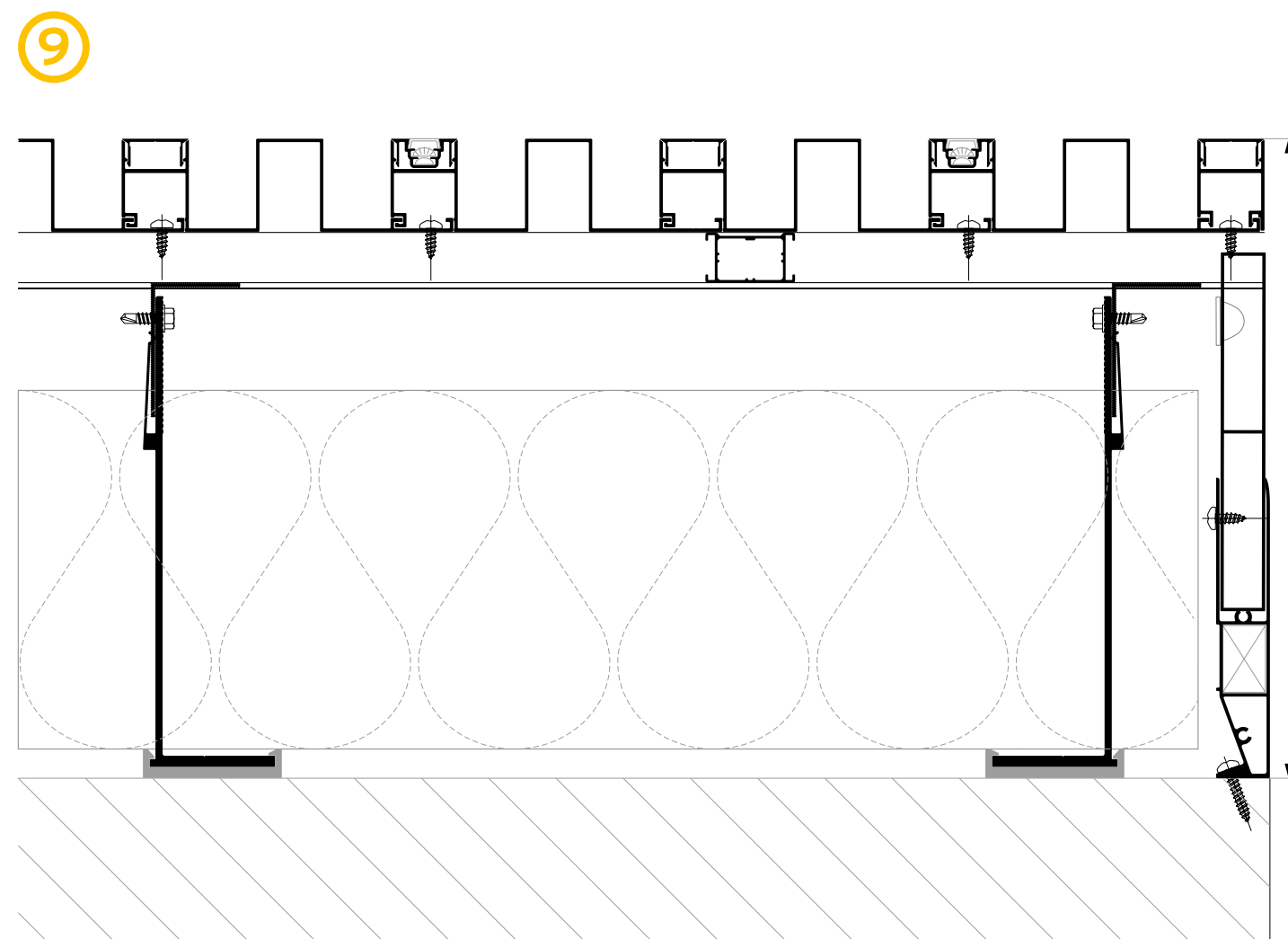
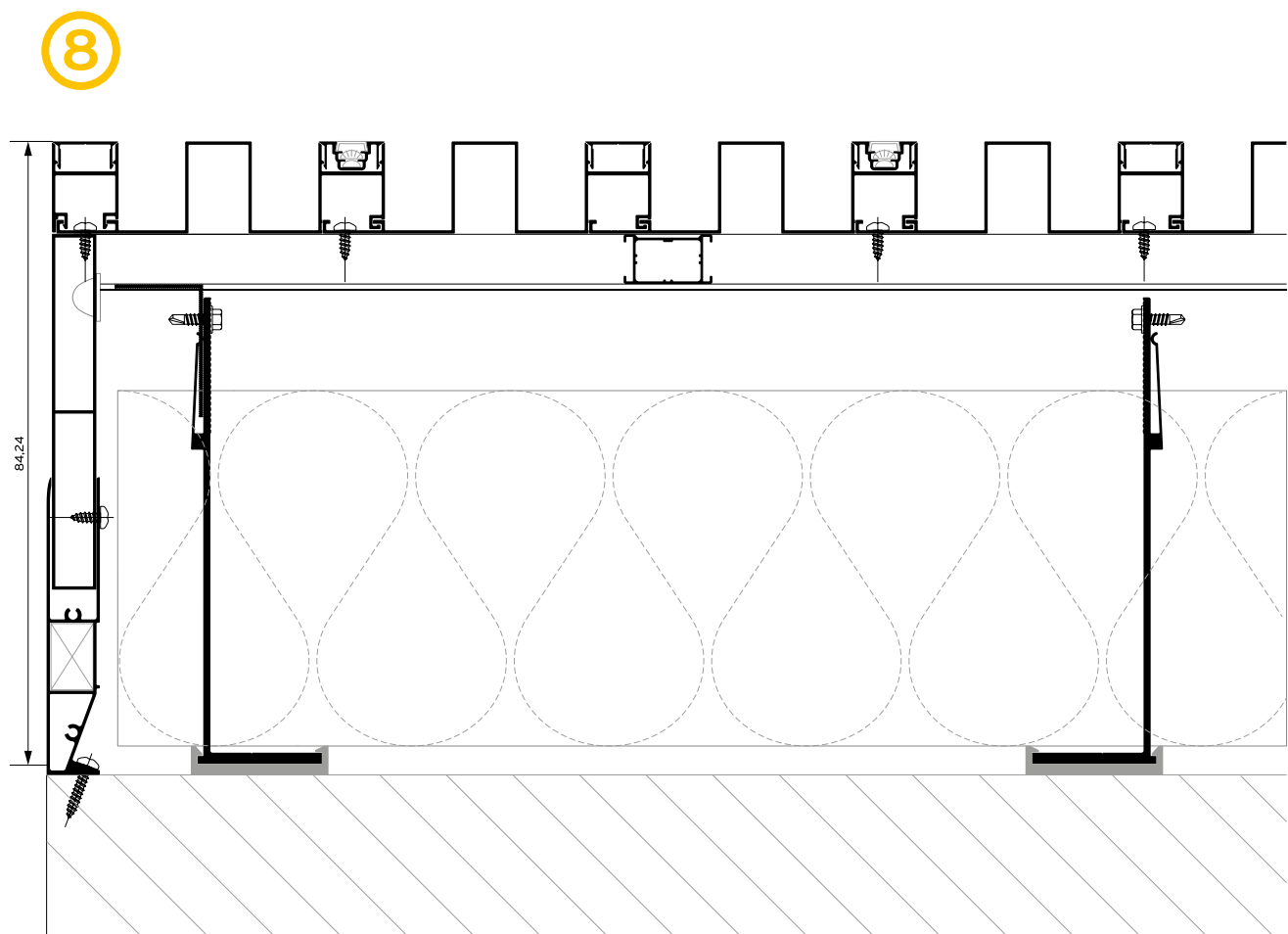
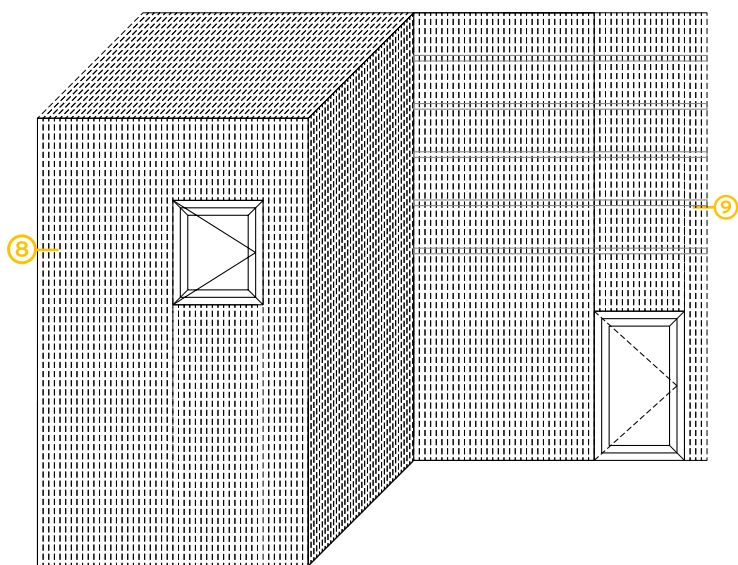

Alumil SMARTIA
Barcode Cladding

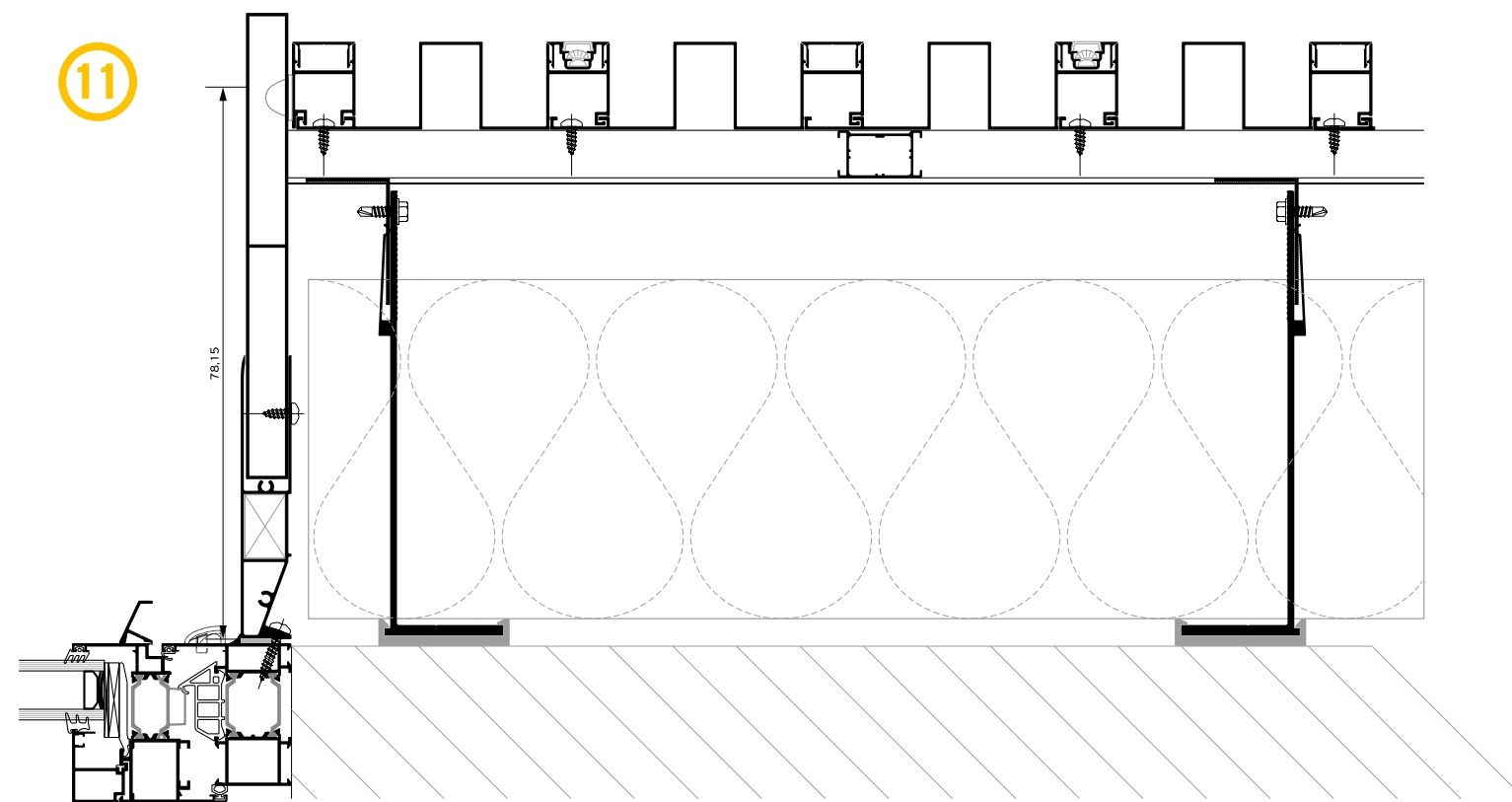
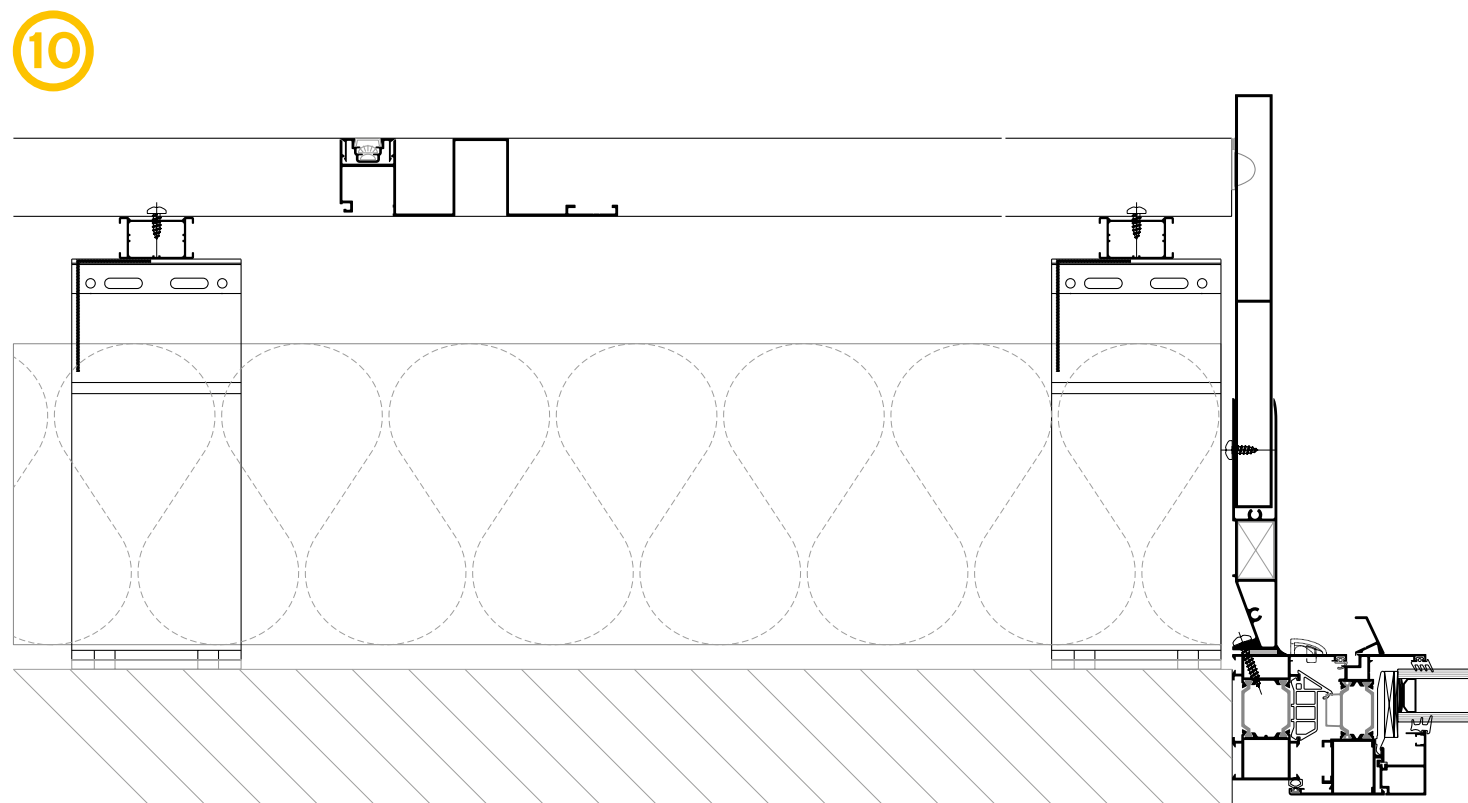
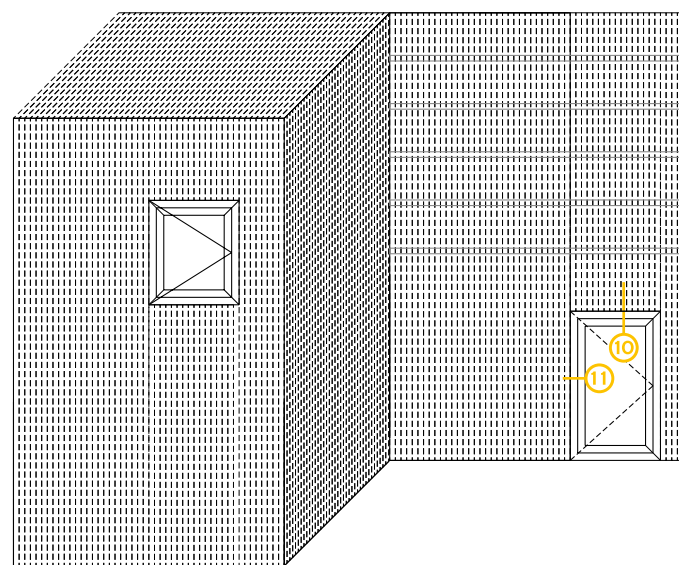

90°
Rotate the technical drawing
90° CLOCKWISE IN ORDER
TO READ IT PROPERLY

Alumil SMARTIA
Barcode Cladding

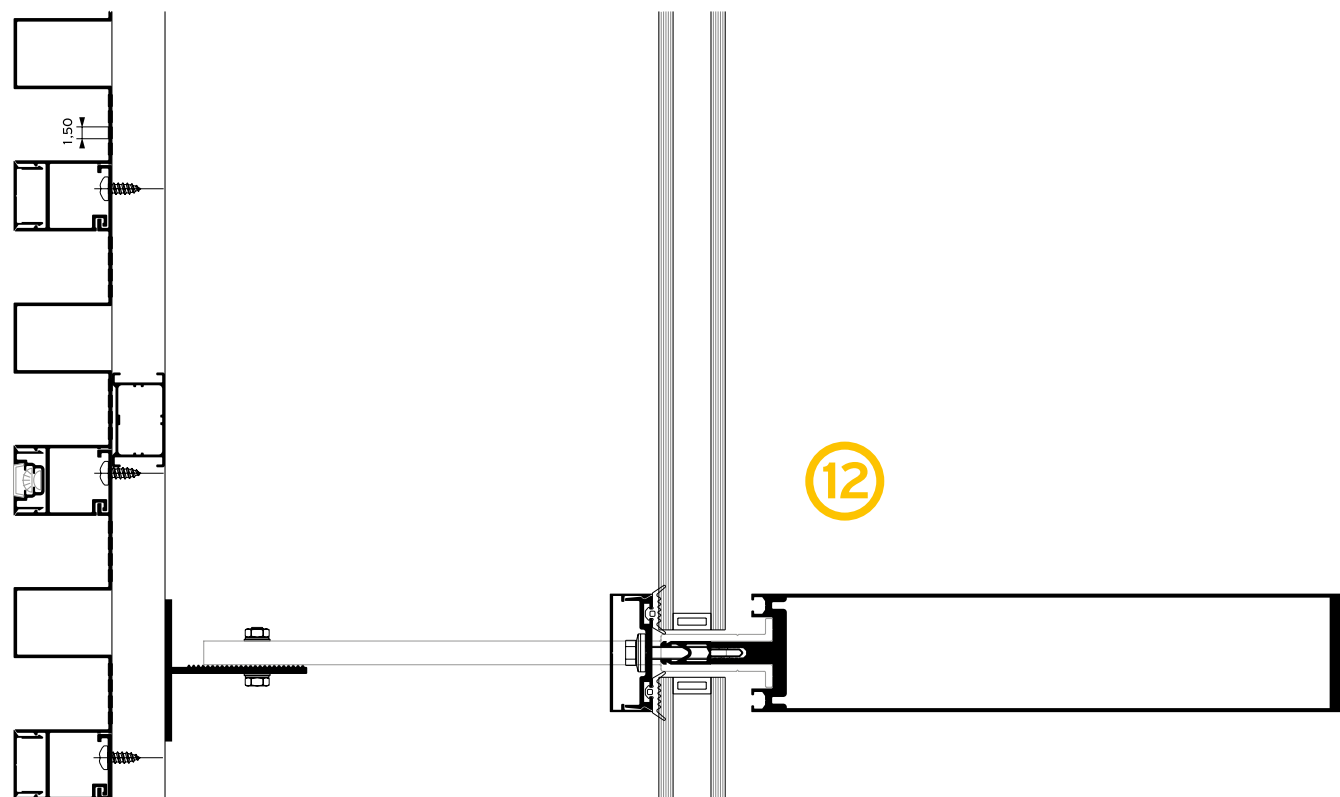
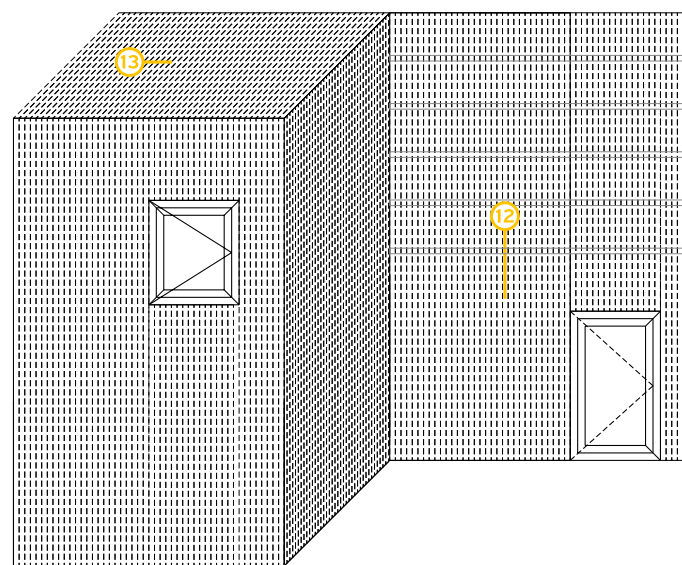

90°
Rotate the technical drawing
90° CLOCKWISE IN ORDER
TO READ IT PROPERLY

13

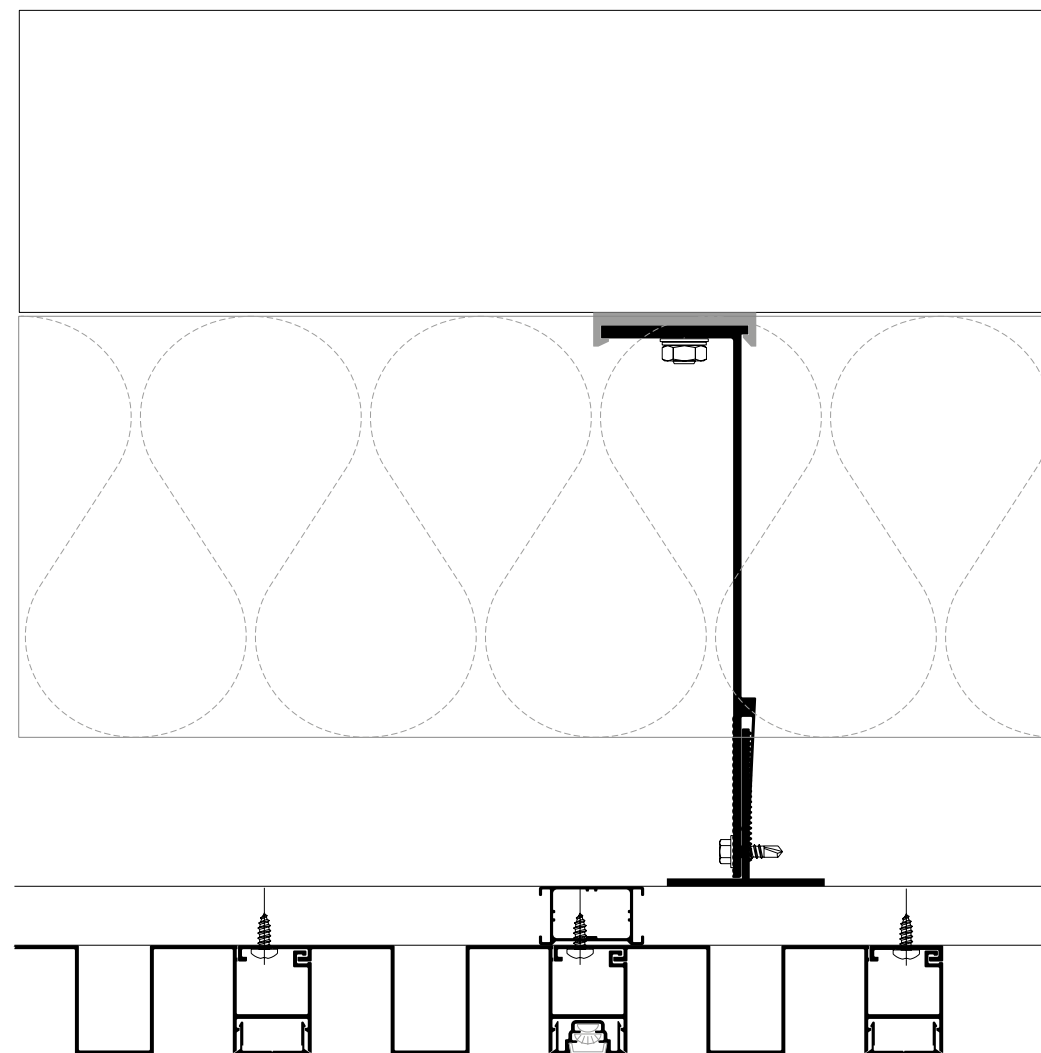

www.alumil.com



**ALUMIL
HEAD OFFICES
& SHOWROOM - THESSALONIKI**

Gogousi 8, Efkarpia
Thessaloniki - GR 56429
TEL.: +30 2313011000
FAX.: +30 231692473
E-MAIL: info@alumil.com

**ALUMIL
HEADQUARTERS**

Kilkis Industrial Area
Kilkis - GR 61100
TEL.: +30 23410 79300
FAX.: +30 23410 71988
E-MAIL: info@alumil.com



**ALUMIL
HEAD OFFICES
& SHOWROOM - THESSALONIKI**

GOGOUSI 8, EFKARPIA
THESSALONIKI - GR 56429

TEL.: +30 2313 011000
FAX.: +30 2310 692473
EMAIL.: info@alumil.com

**ALUMIL
HEADQUARTERS**

KILKIS INDUSTRIAL AREA
KILKIS - GR 61100

TEL.: +30 23410 79300
FAX.: +30 23410 71988
EMAIL.: info@alumil.com

www.alumil.com

alumil

EN FEB 2023